

PIAA AA SE Region

AA

106

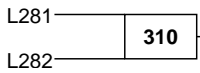
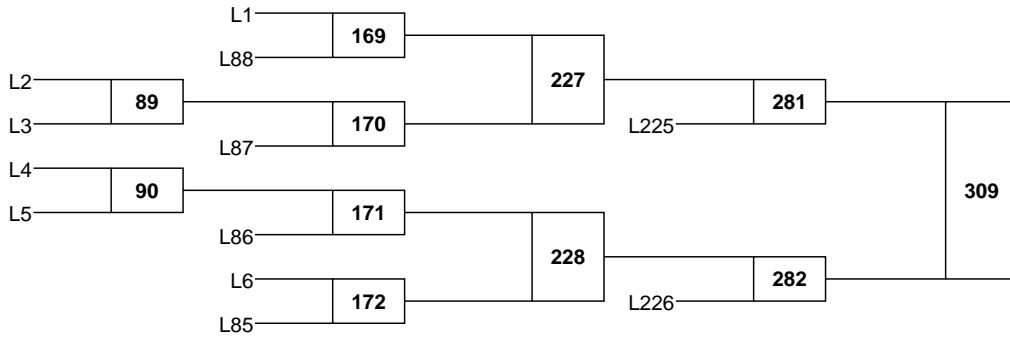
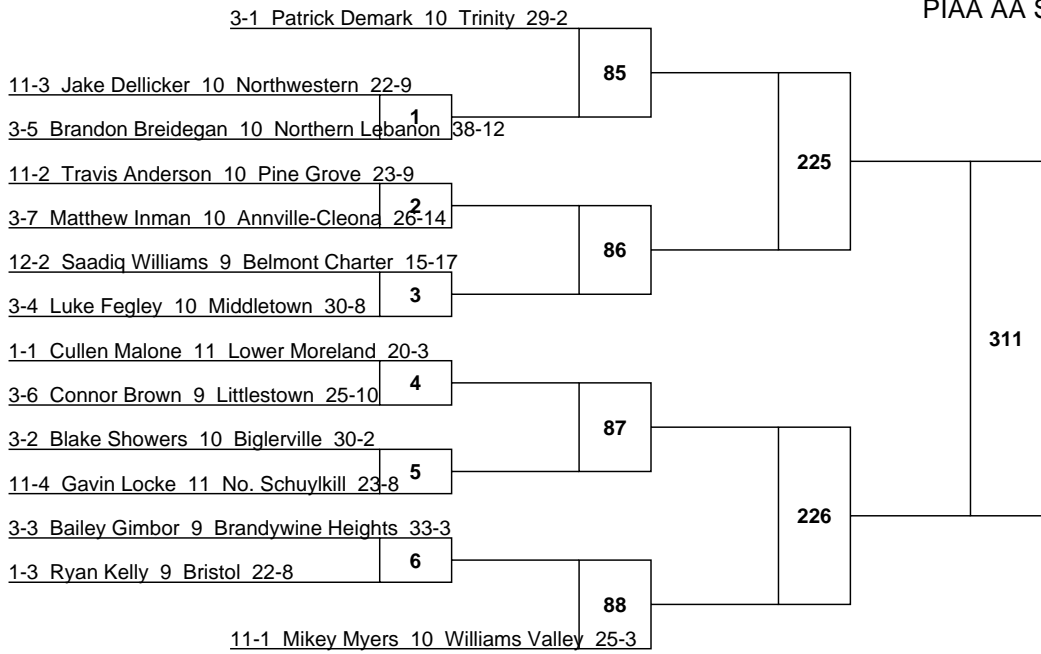

PIAA AA SE Region

AA

113

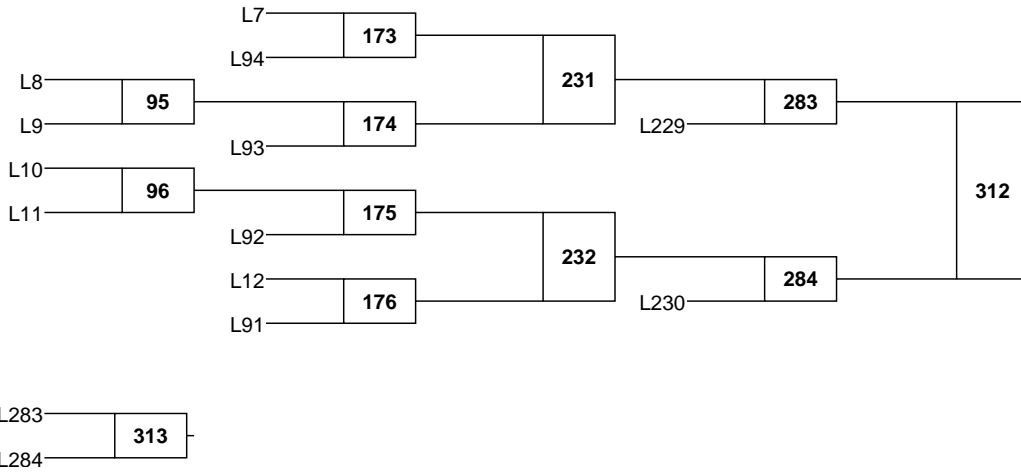
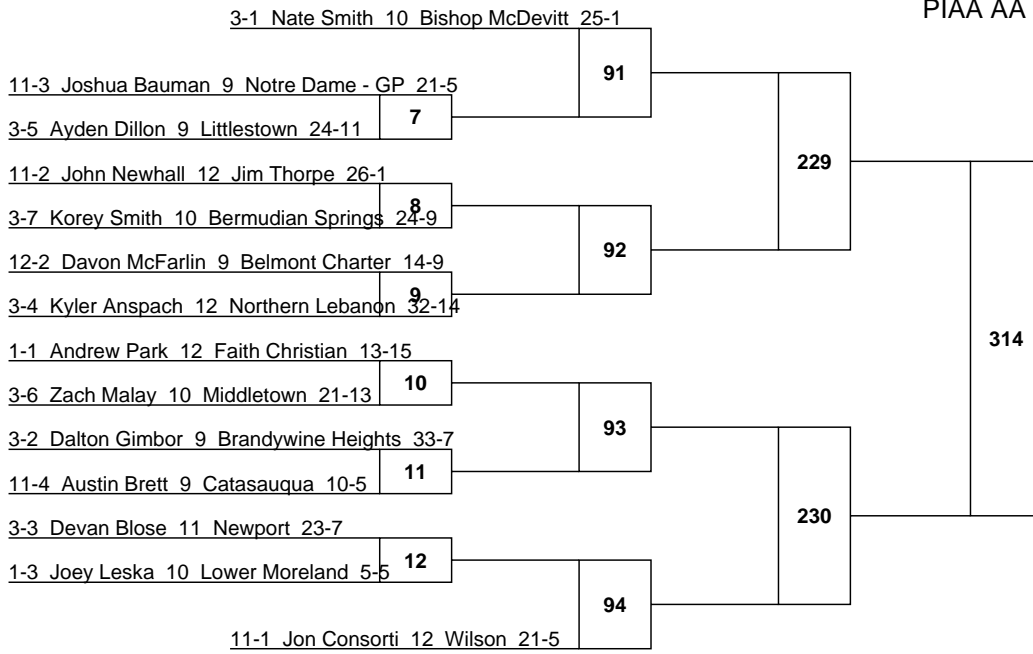

PIAA AA SE Region

AA

120

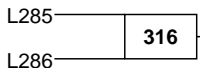
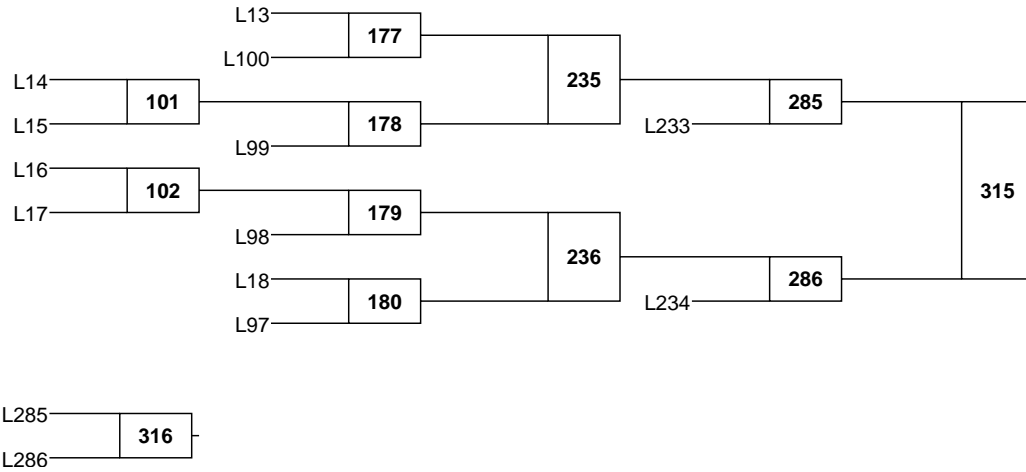
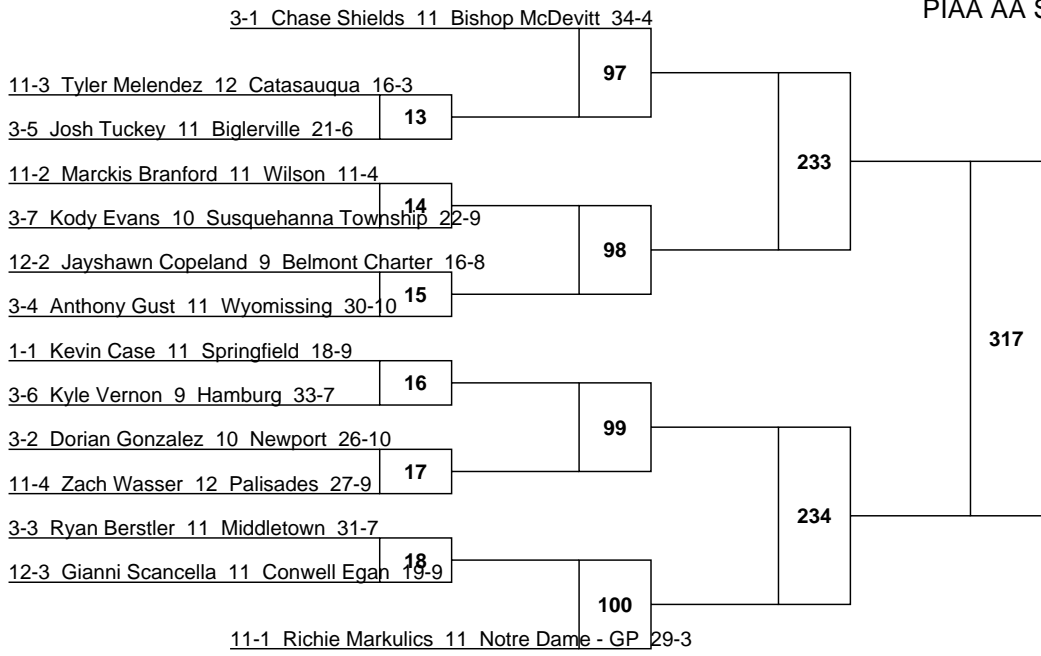

3-1 Colin Leonard 11 Northern Lebanon 44-5

PIAA AA SE Region

AA

126

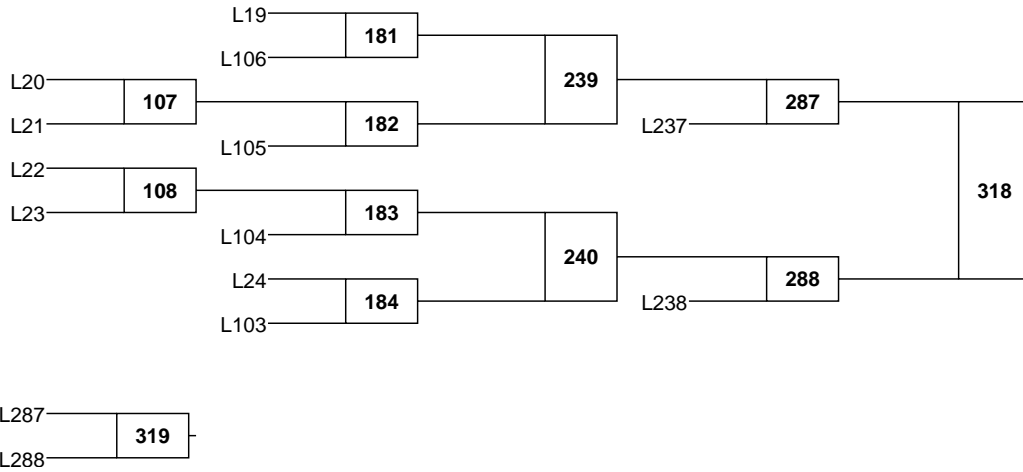
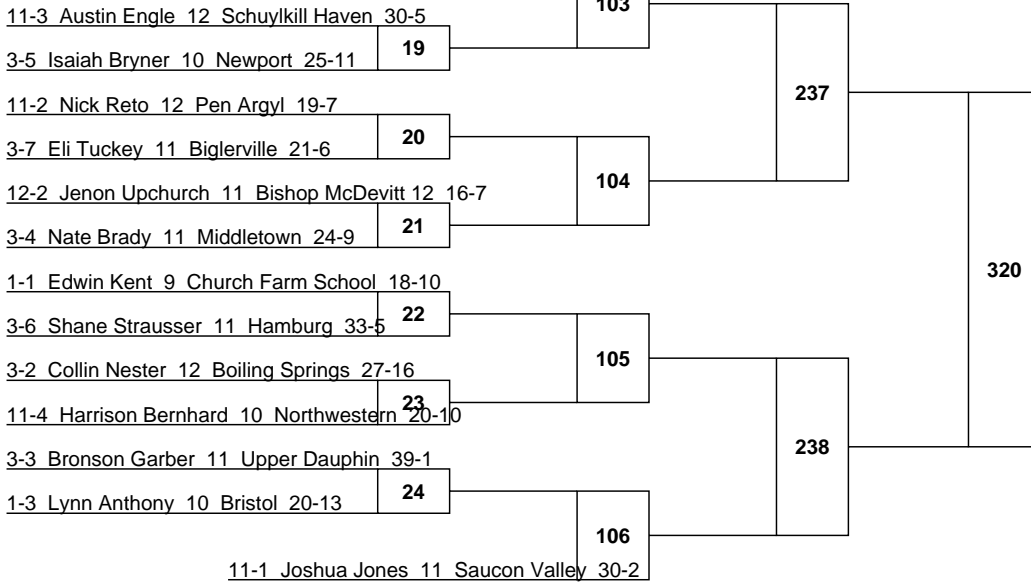

PIAA AA SE Region

AA

132

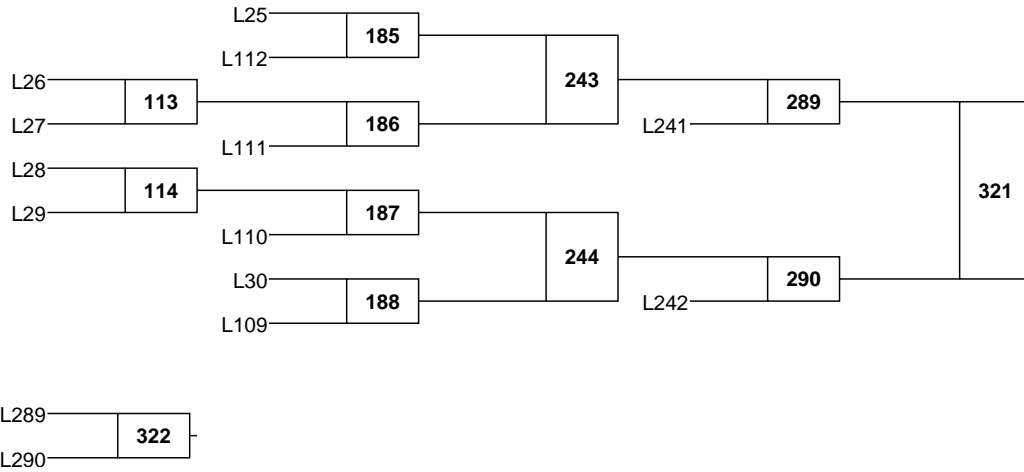
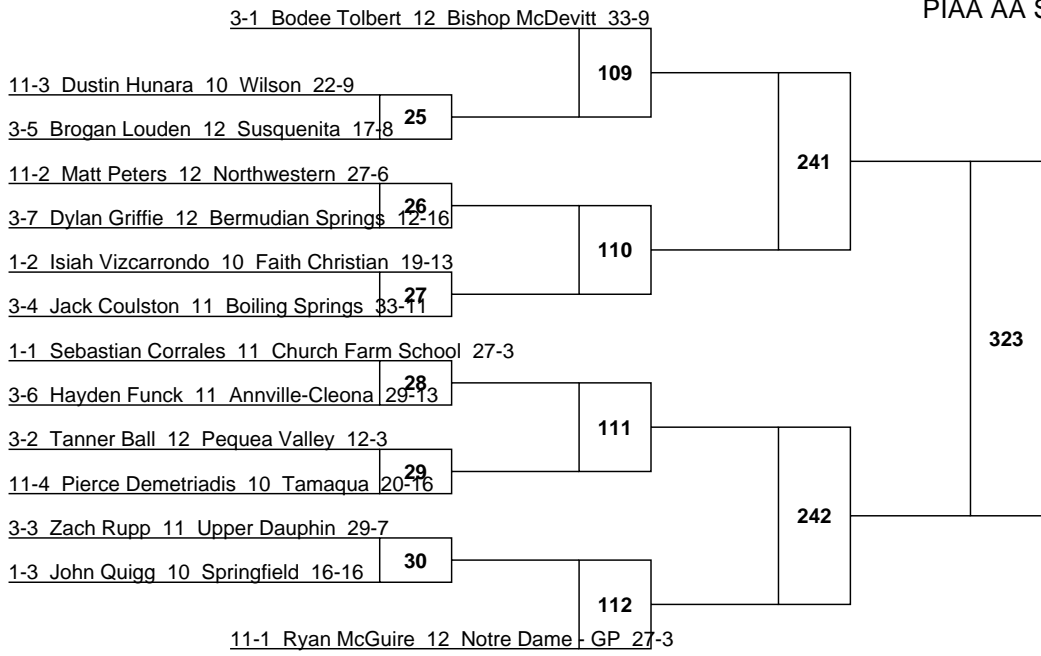

PIAA AA SE Region

AA

138

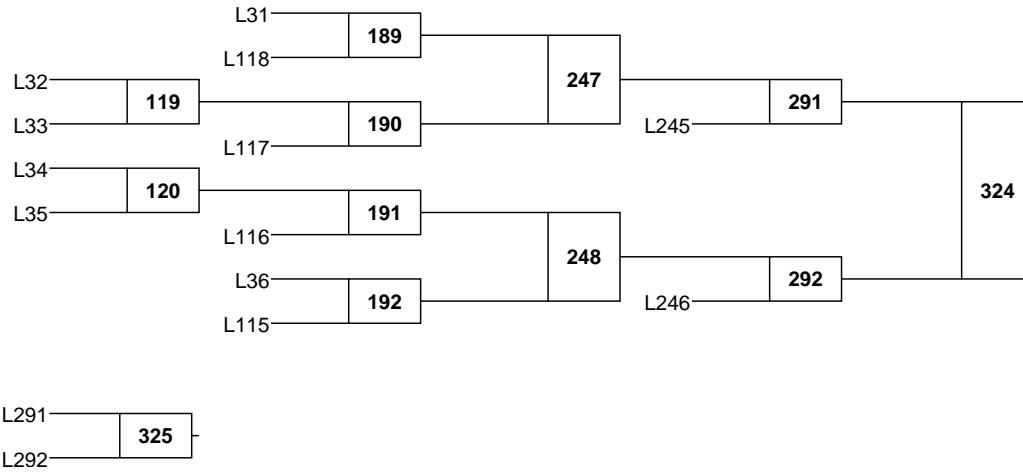
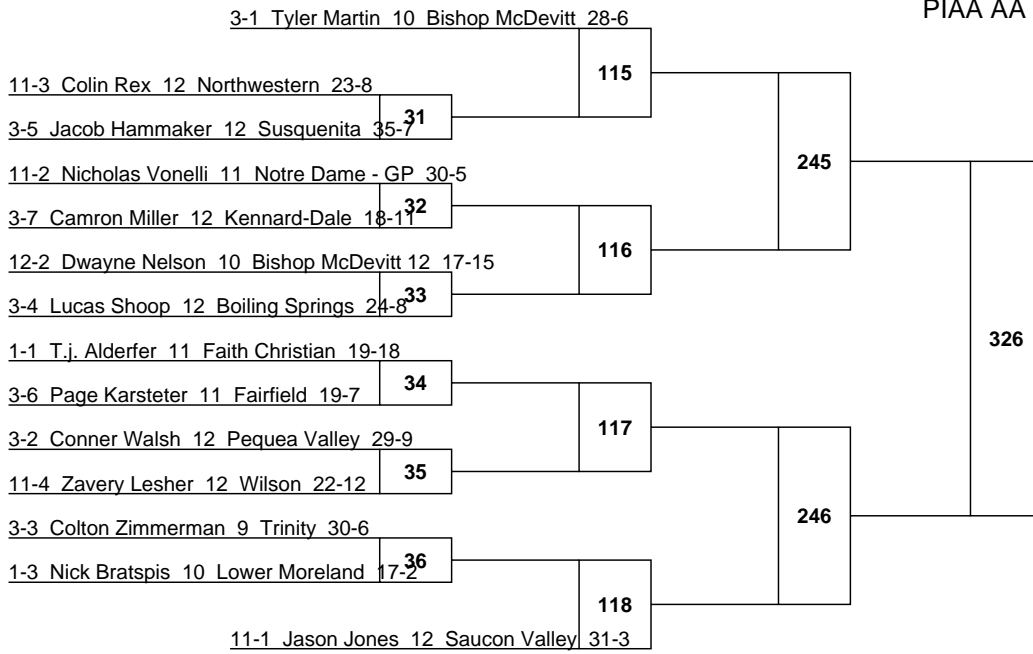

PIAA AA SE Region

AA

145

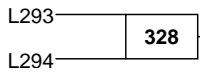
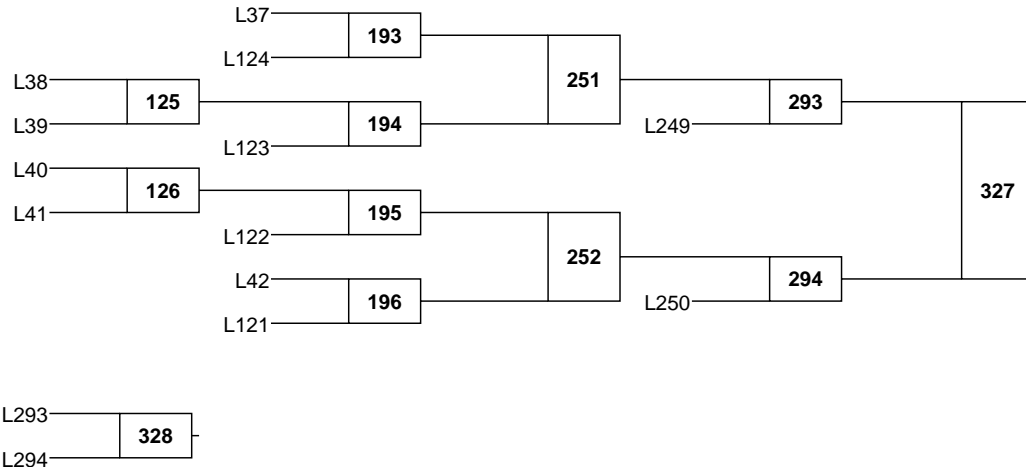
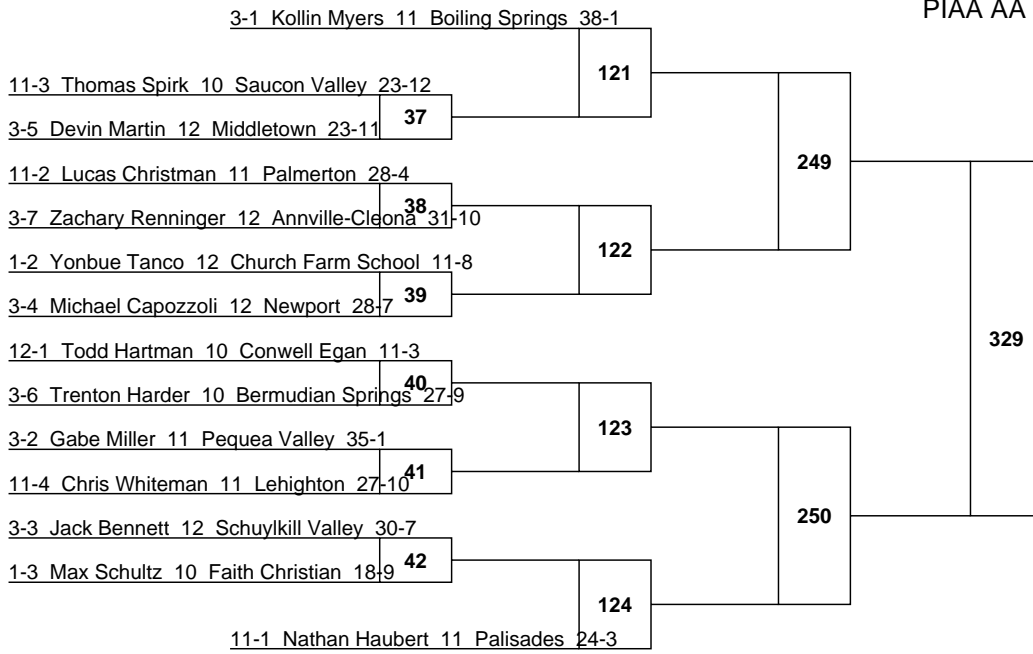

PIAA AA SE Region

AA

152

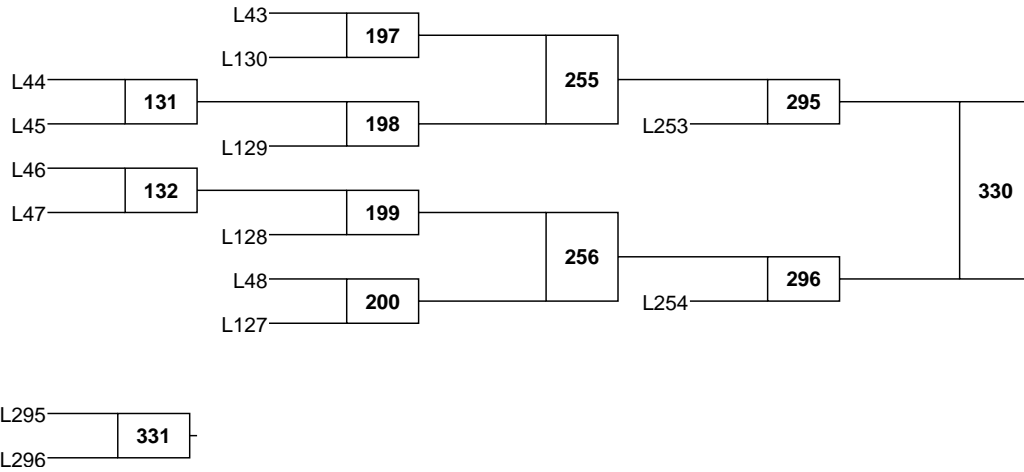
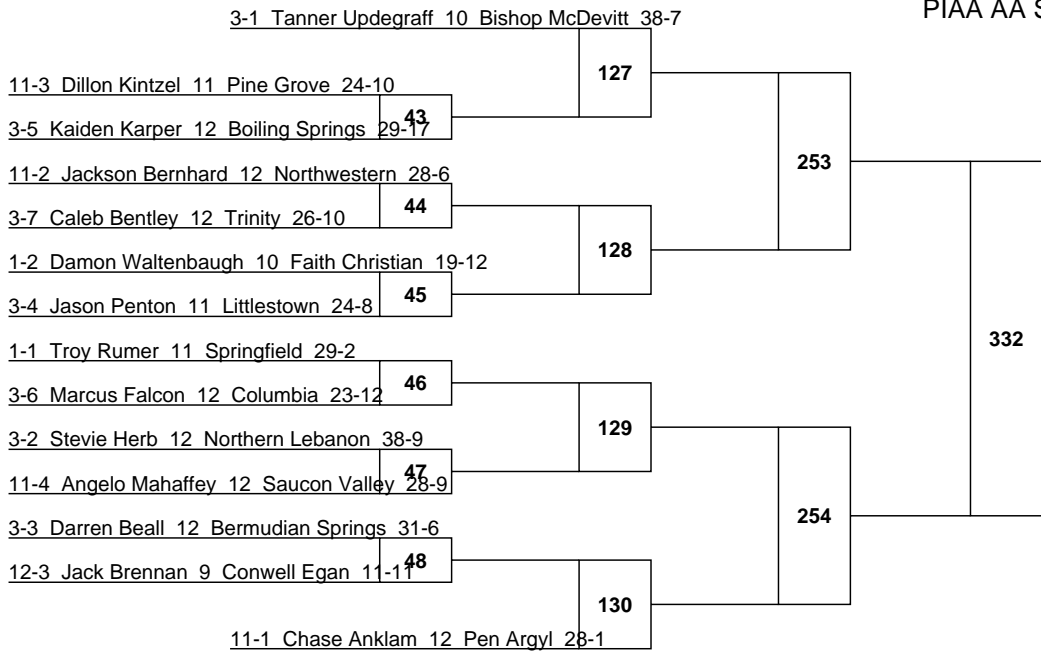



PIAA AA SE Region

AA

160

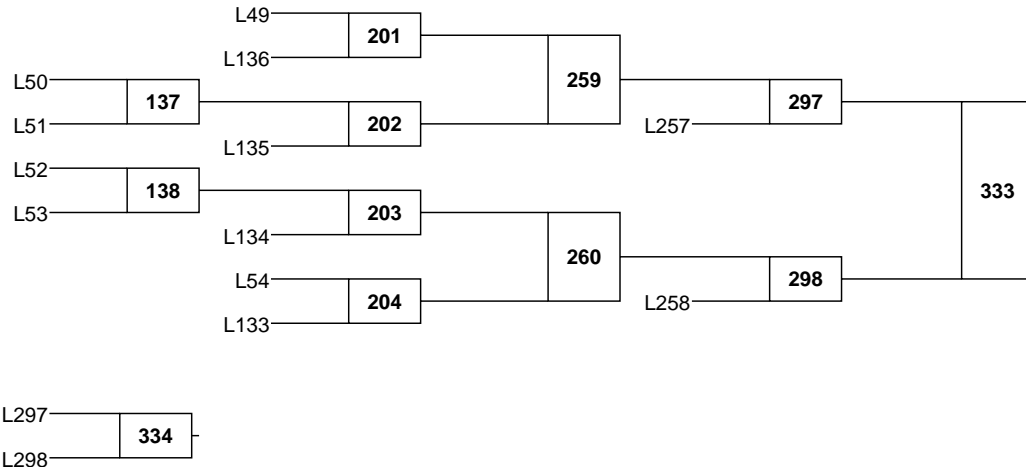
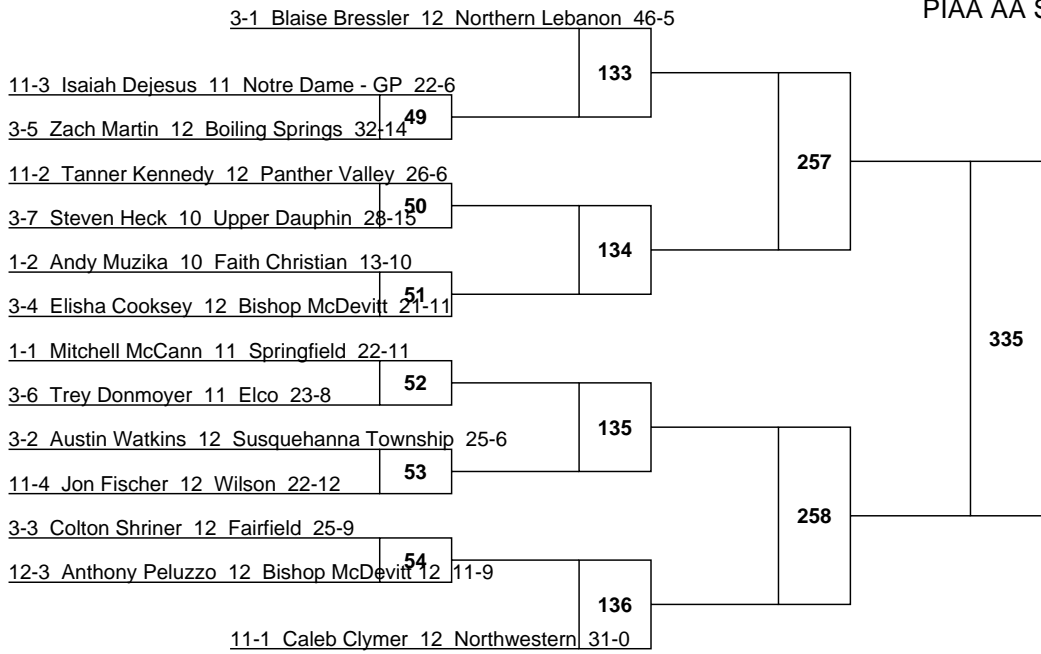

3-1 Edmond Ruth 11 Susquehanna Township 25-0

PIAA AA SE Region

AA

170

11-3 Alec Snyder 10 Wilson 26-7

3-5 Nick Kostyak 11 Boiling Springs 31-14

11-2 Hunter Kennedy 12 Panther Valley 26-7

3-7 Daniel Eagle 12 Kennard-Dale 18-4

12-2 Brian McConville 11 Conwell Egan 3-3

3-4 Tyler Fisher 11 Kutztown 14-3

1-1 Logan Moore 12 Faith Christian 29-5

3-6 Ethan Herb 11 Northern Lebanon 33-14

3-2 Dalton Group 12 Susquenita 33-1

11-4 Cody Scherer 12 Lehighton 8-2

3-3 Carl Harris 11 Littlestown 26-2

12-3 Sean Adolph 11 Bishop McDevitt 12 11-9

11-1 Colin Fegley 11 Mahanoy 30-0

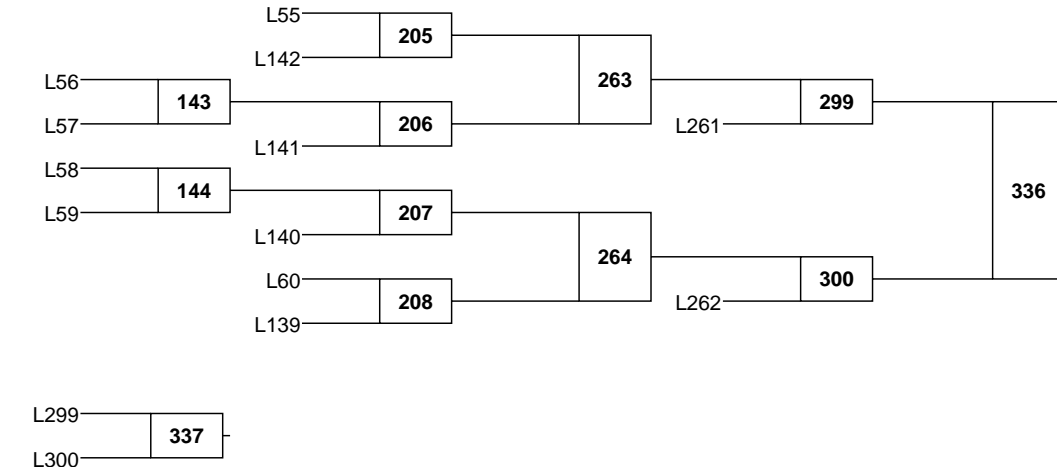

PIAA AA SE Region

AA

182

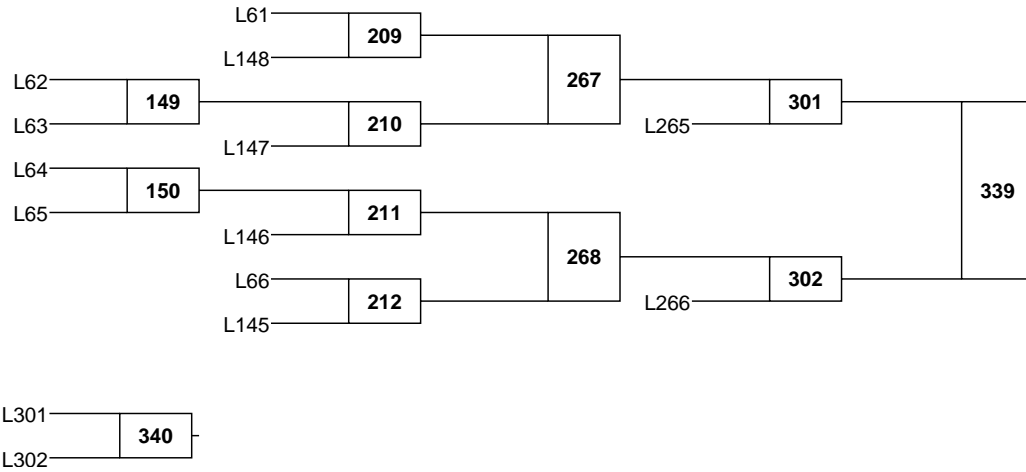
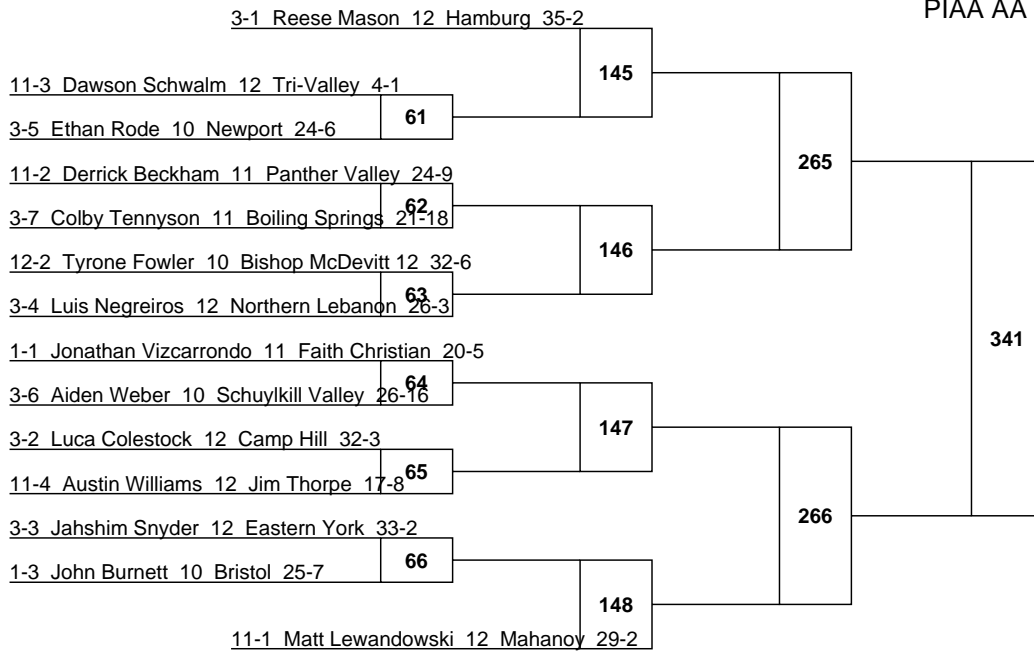

PIAA AA SE Region

AA

195

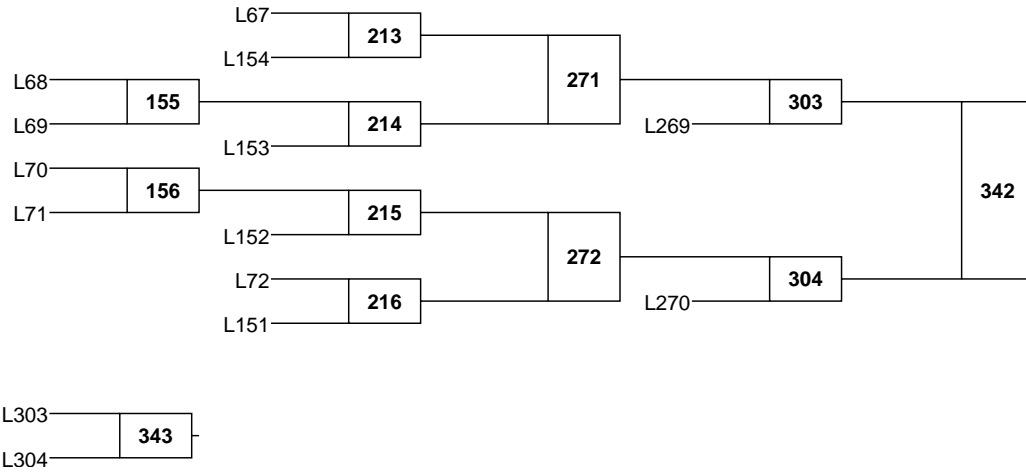
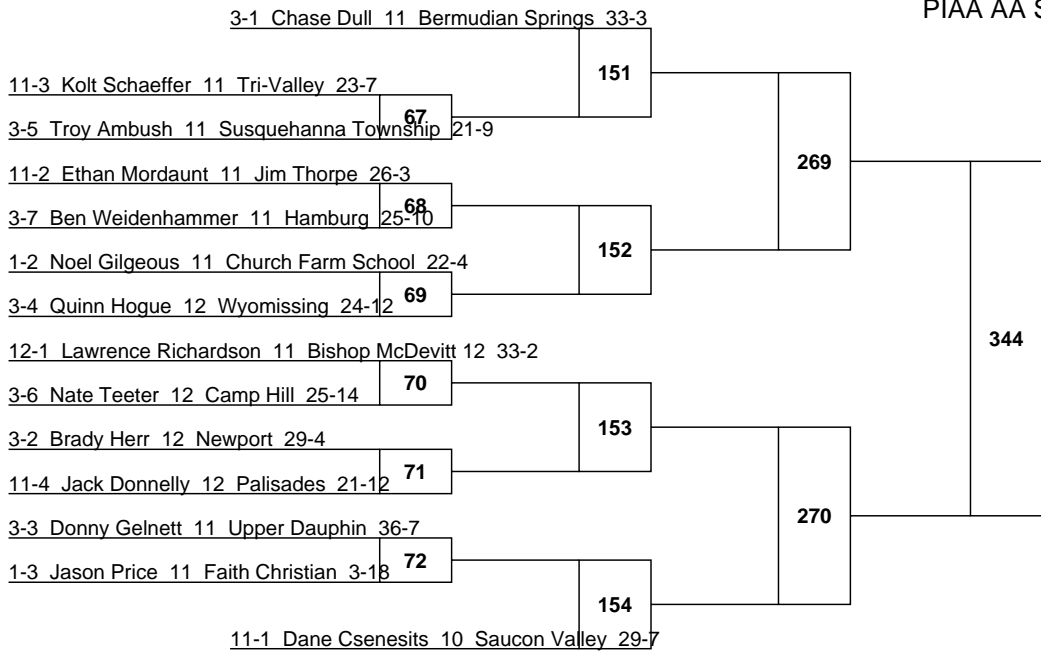

PIAA AA SE Region

AA

220

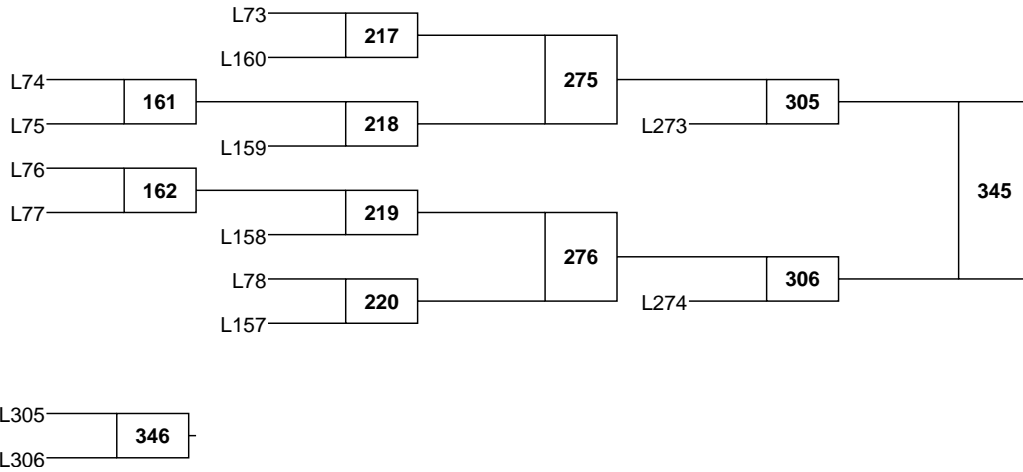
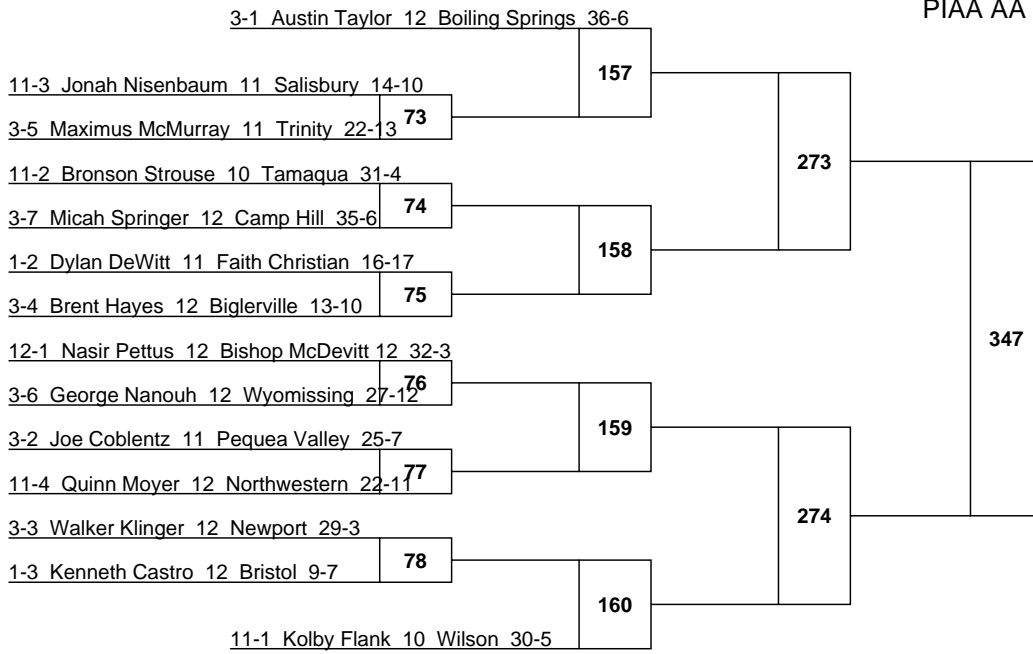

PIAA AA SE Region

AA

285

